

EXTRA

HIGH UV RESISTANT

PSP uPVC windows & doors system

An ISO 9001:2015 ISO 14001:2015 ISO 45001:2018 Certified Organization



Confirming to
**GERMAN
STANDARDS**



ANTIBACTERIAL



ANTI-FUNGALS



CASEMENT - 100 SERIES

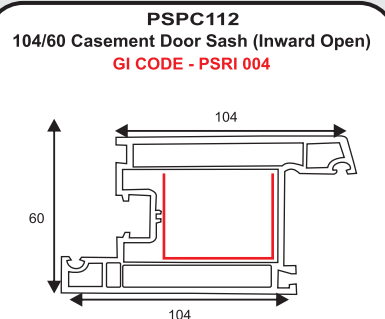
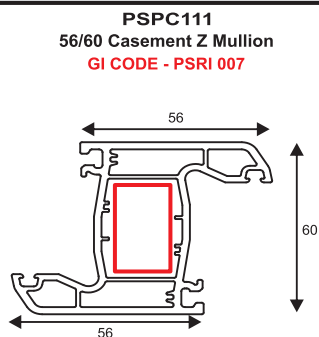
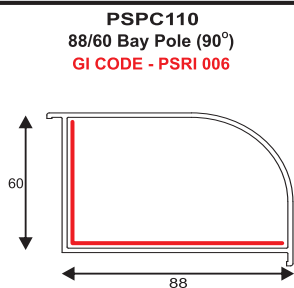
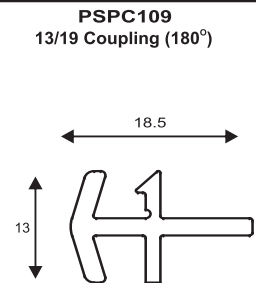
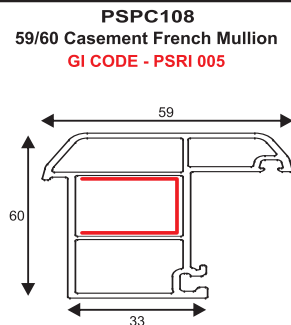
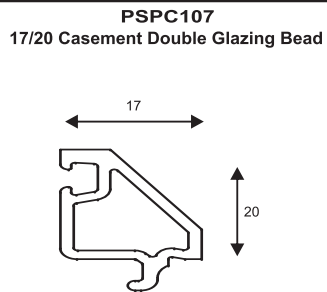
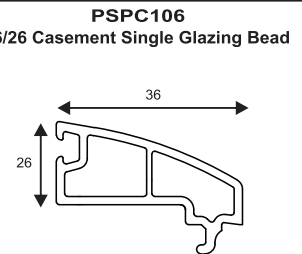
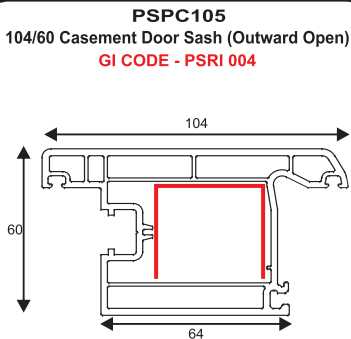
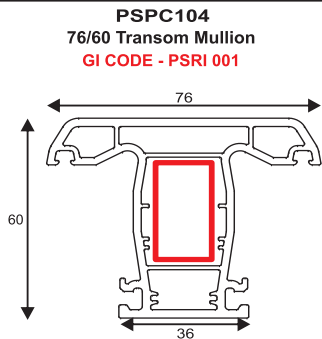
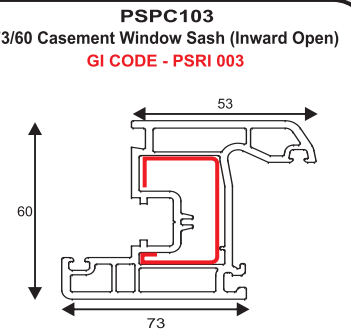
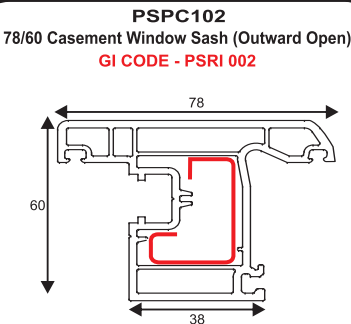
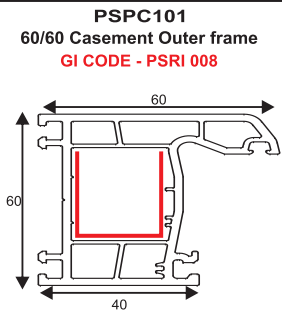
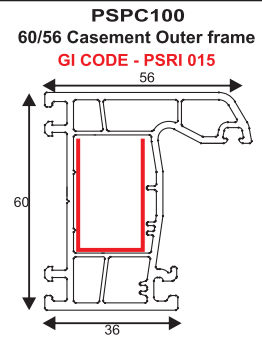
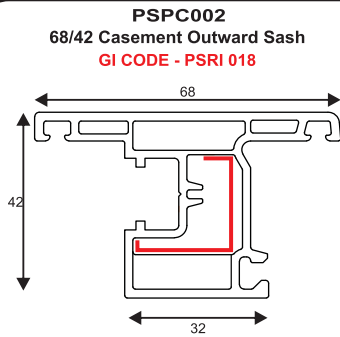
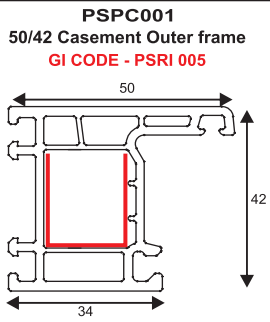

SLIDING - 200 SERIES

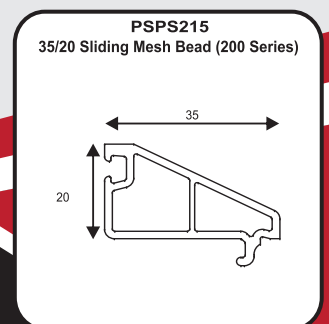
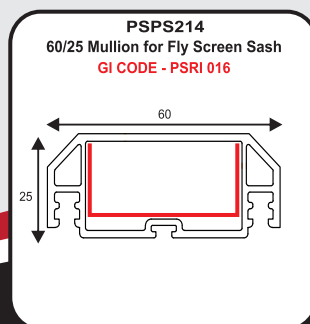
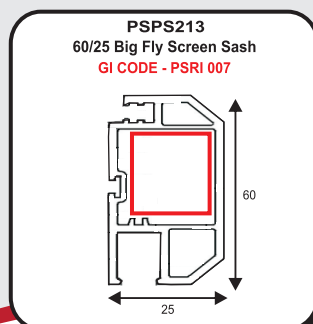
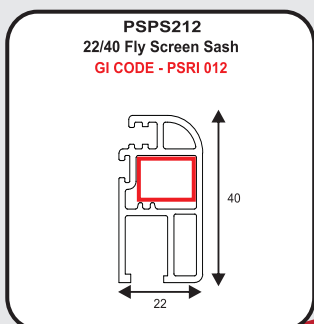
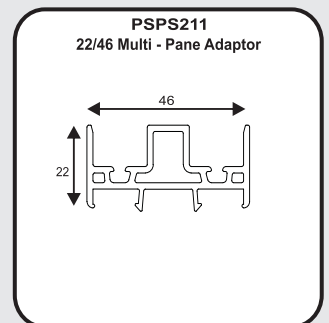
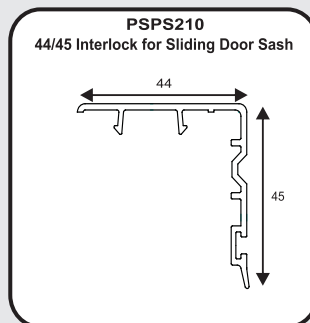
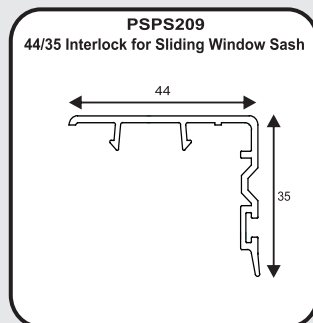
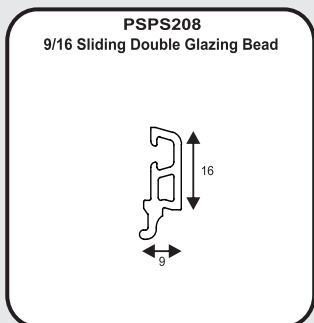
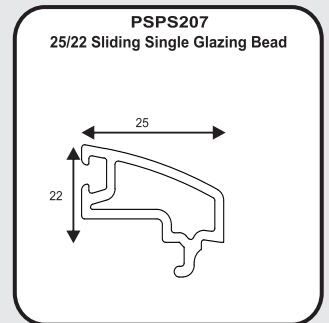
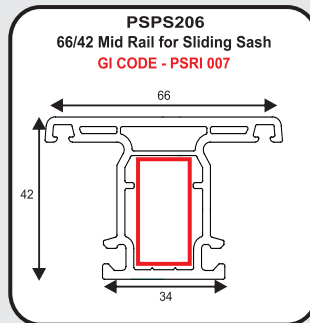
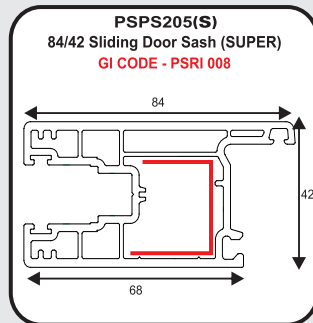
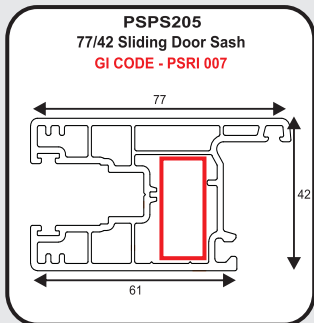
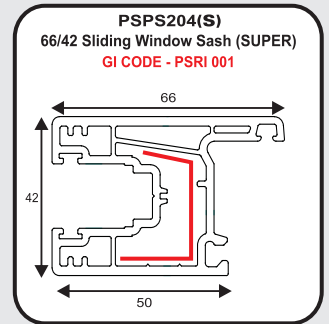
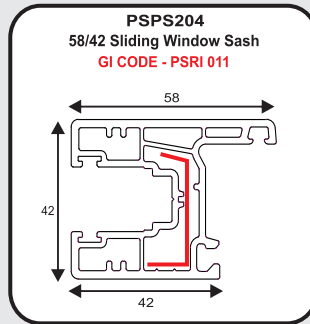
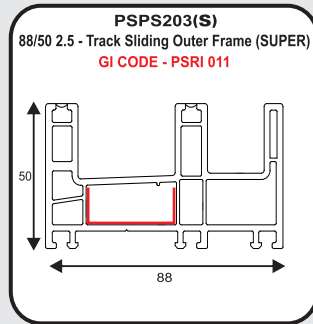
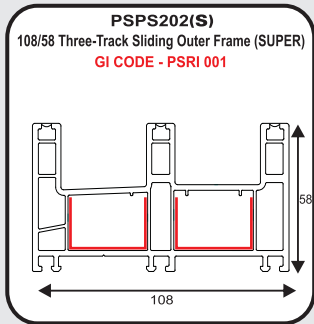
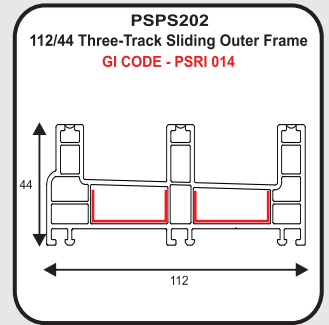
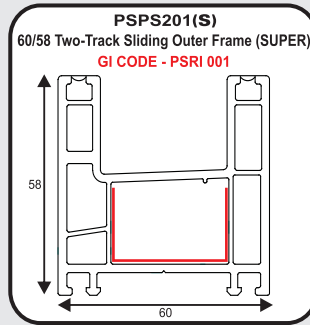
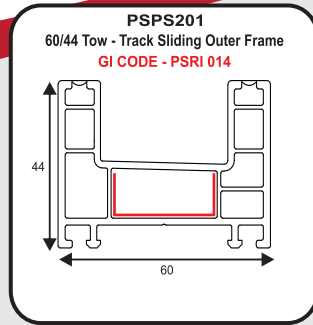
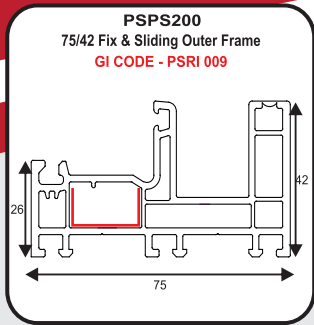

SLIDING - 300 SERIES

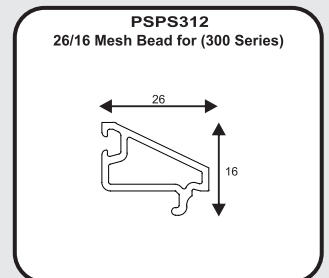
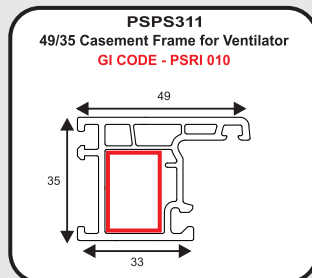
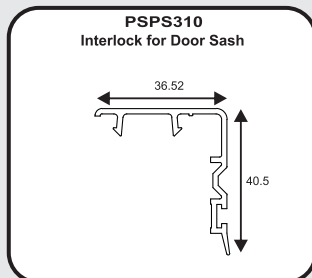
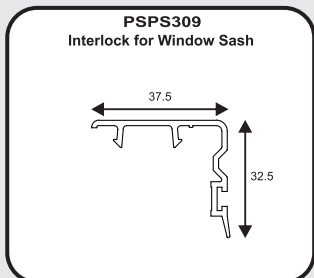
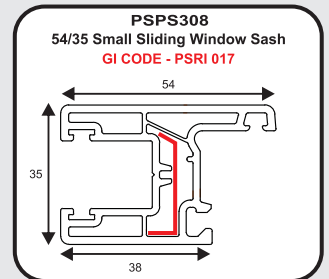
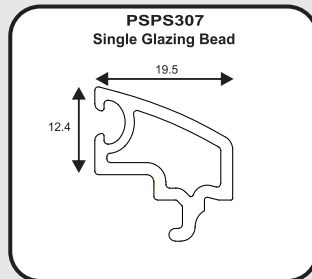
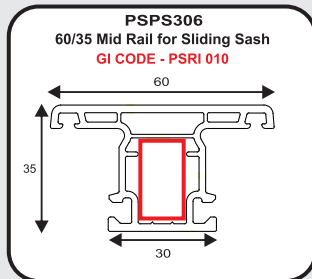
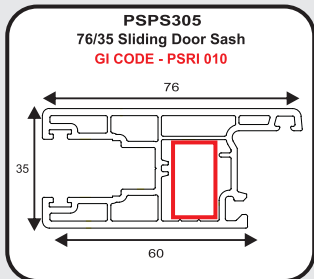
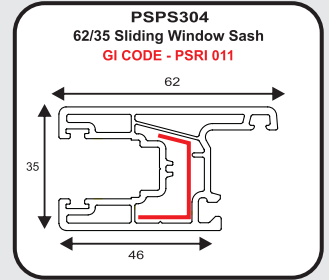
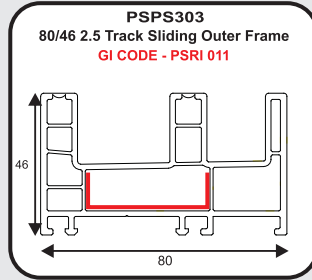
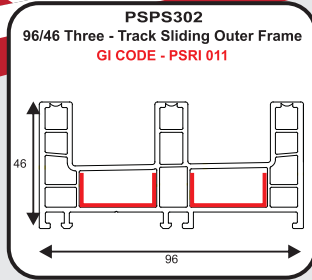
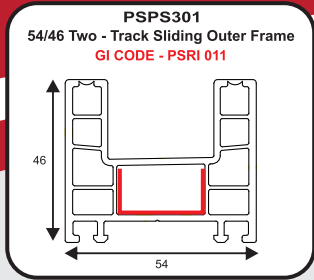

AUXILARY - 400 SERIES

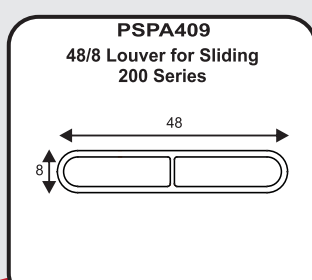
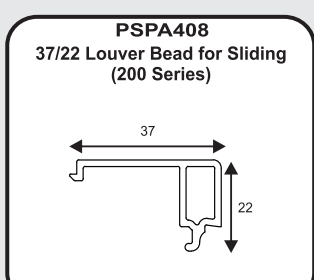
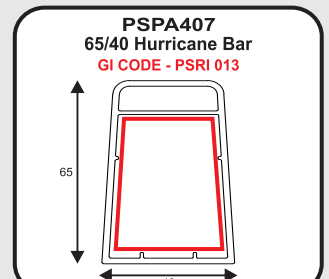
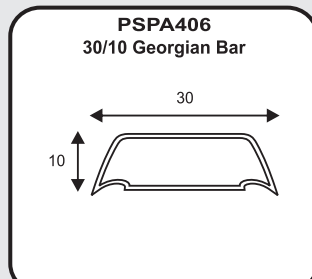
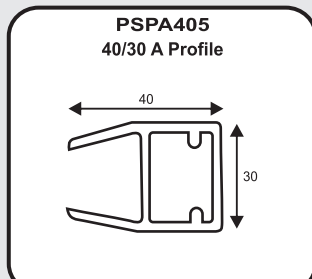
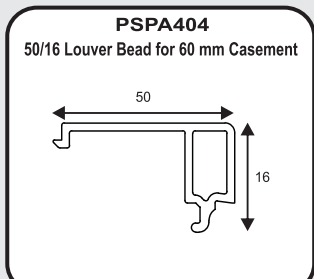
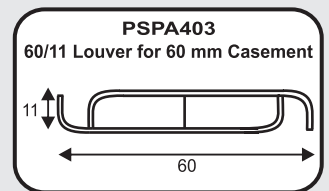
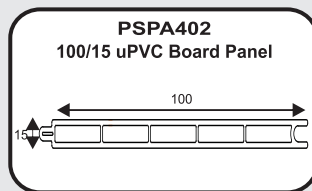
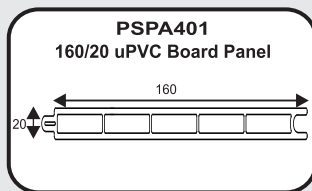
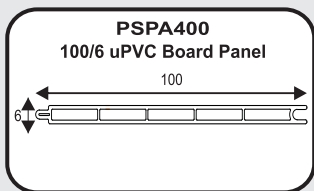



PSP Laminated Profile

PSP offers a wide range of laminated wooden textures with more than 20 colours, which suited to your dream home requirements and these are most suitable for tropical weather conditions and providing 10 years warranty. Laminated profiles are available with brown & white base colour. All laminates are imported from Germany.

Features :

- Extreme weather resistance
- Impact resistance
- Colour stability
- Easy maintenance
- Gloss retention
- Environment friendly

PSP ADVANTAGE

<p>Design Friendly</p> <p>A creative collection of profiles mix-matched with combinations like bayspoles coupled windows, combination windows, etc is our forte.</p>	<p>Extra Durability</p> <p>PSP windows do not warp, twist, or split. Impact modifiers in our profiles are treated with special additives, thereby making the material extremely long lasting.</p>	<p>Air Quality</p> <p>Indoor Air Quality can be maintained by avoiding interior energy loss. PSP windows is are welled design to save energy.</p>
<p>Extra UV Resistance</p> <p>PSP windows offer 100% UV resistance with 8 part of TiO₂, which helps in retaining whiteness against exposure to sun.</p>	<p>Training & Development</p> <p>Intense training on fabrication and installation that makes partner sales team self-reliant & competent to handle customer needs.</p>	<p>Maintenance Free</p> <p>PSP windows are dirt resistant and easy to maintain with normal soap water.</p>
<p>Termite & Corrosion Resistance</p> <p>PSP windows are termite and corrosion resistant. Salts, acids, alkali and waste gases cannot corrode the window systems.</p>	<p>Fire Retardant</p> <p>PSP windows are fire retardant. During fire, once source of fire is removed, a carbonaceous layer is formed preventing supplying of oxygen and stops the spread.</p>	<p>Sound Insulation</p> <p>Not only do they provide thermal insulation but also special sound insulation.</p>
<p>Lead Free Profile</p> <p>Lead being a cancer generating agent, we develop lead free profile to avoid health hazards to people. It also provides longer window life with stronger weld strength and better UV resistance.</p>	<p>Wide Product Ranges</p> <p>Unique versatile designs with engineering principles have led to development of various profile that are suitable for budget apartments to most premium villas.</p>	<p>Large Reinforcement Space</p> <p>PSP strategic designing of reinforcement space allows large doors for sunlight & scenic view and usage in high rises.</p>



PSP DYNAMIC LIMITED.

Head Office: 2nd Floor A-27, Sector 67, Noida (UP) INDIA +91-120-3100329 / 4277674
+91 8058591436 / 8824900412 / 8824900437 / 8824900411 / 8824900422 / 8824900429

Works: 26-A & B Old Industrial Area, Alwar (Raj) India +91- 144-2945600 / +91 8824900431 - 435

Branch Offices :

- GUWAHATI :** Shine Towers, Arya Chowk, SJ Road, Guwahati - 781008 +91-9864038101 / 9435073291 / 8824900424 / 8851032245
- BANGALORE :** 90/2 Punyakoti Farm, Village - Kogilu, Yelahanka Bengaluru +91-8824900414 / 8824900441 / 8824900442
- HYDERABAD :** Sy No. 5, H.No. 6-135/2/3 Bowrampet, Hydrabad-500043 +91-8824900414 / 8824900441 / 9333029999
- BHUVNESHWAR :** 8824900410 / 8824900424 | **MUMBAI :** 8824900454 / 8824900410 | **PATNA :** 9430606921 / 9219602028 / 8824900416
- RAJASTHAN & GUJRAT :** 8824900455 / 8824900412 | **KATHMANDU :** +977-9821621756 / 8824900410 | **DHAKA :** 8824900412 / 8824900410

Visit us: www.pspdynamic.com | **Email:** info@pspdynamic.com | **Technical Desk:** +91- 8824900412, 8824900433, 8824900440